

This article was downloaded by:

On: 24 January 2011

Access details: *Access Details: Free Access*

Publisher *Taylor & Francis*

Informa Ltd Registered in England and Wales Registered Number: 1072954 Registered office: Mortimer House, 37-41 Mortimer Street, London W1T 3JH, UK



## Journal of Macromolecular Science, Part A

Publication details, including instructions for authors and subscription information:

<http://www.informaworld.com/smpp/title~content=t713597274>

### Immobilization of Ciliary Neurotrophic Factor on Model Biomaterials by Plasma Graft Polymerization

Xiangmei Wang<sup>a</sup>; Jing Zhang<sup>ab</sup>; Hao Chen<sup>b</sup>; Qingrui Wang<sup>a</sup>

<sup>a</sup> The State Key Lab of Modification for Chemical Fibers and Polymer Materials, College of Materials Science & Engineering, Donghua University, Shanghai, P.R. China <sup>b</sup> College of Basic Sciences, Donghua University, Shanghai, P.R. China

**To cite this Article** Wang, Xiangmei , Zhang, Jing , Chen, Hao and Wang, Qingrui(2006) 'Immobilization of Ciliary Neurotrophic Factor on Model Biomaterials by Plasma Graft Polymerization', *Journal of Macromolecular Science, Part A*, 43: 11, 1721 – 1731

**To link to this Article:** DOI: 10.1080/10601320600939312

**URL:** <http://dx.doi.org/10.1080/10601320600939312>

PLEASE SCROLL DOWN FOR ARTICLE

Full terms and conditions of use: <http://www.informaworld.com/terms-and-conditions-of-access.pdf>

This article may be used for research, teaching and private study purposes. Any substantial or systematic reproduction, re-distribution, re-selling, loan or sub-licensing, systematic supply or distribution in any form to anyone is expressly forbidden.

The publisher does not give any warranty express or implied or make any representation that the contents will be complete or accurate or up to date. The accuracy of any instructions, formulae and drug doses should be independently verified with primary sources. The publisher shall not be liable for any loss, actions, claims, proceedings, demand or costs or damages whatsoever or howsoever caused arising directly or indirectly in connection with or arising out of the use of this material.

# Immobilization of Ciliary Neurotrophic Factor on Model Biomaterials by Plasma Graft Polymerization

XIANGMEI WANG,<sup>2</sup> JING ZHANG,<sup>1,2</sup> HAO CHEN,<sup>1</sup>  
AND QINGRUI WANG<sup>2</sup>

<sup>1</sup>College of Basic Sciences, Donghua University, Shanghai, P.R. China

<sup>2</sup>The State Key Lab of Modification for Chemical Fibers and Polymer Materials, College of Materials Science & Engineering, Donghua University, Shanghai, P.R. China

*Acrylic acid was grafted on the surface of polypropylene (PP) film via plasma-induced technology. It was shown by FT-IR that there were carboxyl groups on the surface of the modified PP film. The grafting ratio was analyzed quantitatively through a dyeing process. The effects of the technology parameters of the plasma-treatment and graft polymerization on the grafting ratio, such as power, discharge time, concentration of monomer and active species density, reaction temperature and time, were characterized. Moreover, the content of ciliary neurotrophic factor (CNTF) that was anchored on the surface of the modified PP film was measured through enzyme-linked immunosorbent assay (ELISA). The results show that the amount of CNTF immobilized on the surface of the modified PP film increase with increasing content of carboxyl groups, showing that the existence of carboxyl groups on the surface of the PP film is beneficial to the immobilization of CNTF.*

**Keywords** polypropylene, grafting, plasma, acrylic acid, ciliary neurotrophic factor, immobilization

## Introduction

Polymeric materials with biologically active components immobilized on their surface are of great importance for a diversity of biotechnological and medical applications. In order to covalently immobilize biomacromolecules, such as insulin, protein, growth gene, heparin, etc., onto polymer surfaces, they are required to have functional groups such as amine, imine, carboxyl, hydroxyl, etc. Several papers have described the introduction of functional groups to the surface of polymeric materials using plasma-induced technology (1–13). The main advantages of plasma-induced polymerization are: (1) No obvious effect on the substrates because of the reaction depth of only tens of nanometer. (2) No special requirement for the surface shape of the materials. Therefore, low temperature plasma-induced polymerization is a kind of ideal surface-treatment technology for medical materials.

Address correspondence to Jing Zhang, College of Basic Sciences, Donghua University, 1882 West Yan-an Road, Shanghai 200051, P.R. China. Tel.: + 86-021-62373947; E-mail: jingzh@dhu.edu.cn

Various biomaterials, including poly(lactic acid-co-glycolic acid) (PGLA), polyurethane, etc. have been tried to immobilize heparin, growth gene through plasma induced polymerization to improve their blood compatibility or cell adhesion. The ordinary way is to treat the biomaterials by argon, oxygen or  $\text{NH}_3$  plasma first to introduce some free radicals, COOH,  $\text{NH}_2$  or OH groups on the biomaterial's surface. Then the treated biomaterials are immersed in acrylic acid or acrylamide solution to graft chains with COOH,  $\text{NH}_2$  or OH end groups. After that, they are put into heparin or growth gene solutions to immobilize the bio-macromolecules. But because the immobilized bio-macromolecules usually have similar elements and molecular structure as the biomaterials and the amount of the immobilized bio-macromolecules is too little to measure, it is very difficult to characterize the surface changes of the biomaterials and therefore, the grafting and immobilizing mechanism. For this reason, a model polymer-polypropylene, of simple structure with only carbon and hydrogen atoms,  $\text{CH}_2$  and  $\text{CH}_3$  groups, and easy analysis, was chosen to investigate the modification process and mechanism in this paper.

In this research, the effects of the technology parameters of plasma-treatment and graft polymerization on the grafting ratio of acrylic acid on polypropylene were characterized using a plasma-inducing installation designed by ourselves. The amount of ciliary neurotrophic factor (CNTF) that was immobilized on the surface of the modified PP film was measured quantitatively through enzyme-linked immunosorbent assay (ELISA). CNTF has been proven to improve the neural cell adhesion and growth in much previous research. If it can be immobilized on the bio-materials surface, it will have potential applications in artificial neural tubes used for improving regeneration of defective nerves. Such factors as power, discharge time, concentration of monomer, number of pieces of treated PP, grafting reaction temperature and time were examined. The results show that CNTF was effectively immobilized on the PP film surface. The amount of CNTF immobilized on the surface of the modified PP film increased with increasing content of carboxyl groups, showing that the existence of carboxyl groups on the surface of the PP film were beneficial to the immobilization of CNTF.

## Experiment

### *Plasma Treatment and Graft Polymerization*

The plasma treatment of the PP films, with a size of  $1.2 \times 2.5 \text{ cm}^2$ , that were previously immersed in acetone for 12 h and dried, was carried out in plasma reactor device with a 13 cm diameter and a 60 cm length and a connected capacitance coupling (Figure 1). The film was placed on the grounded electrode. When the pressure of the reactor was pumped down under 20 Pa, the plasma power was turned on and the samples were treated and cleaned by air plasma of 20w for 2 min. Then, the acrylic acid was led into the reactor and the pressure was kept at 35 Pa. The samples were treated by acrylic acid plasma with a power of 20w to 80w for 0.5 min to 20 min. After the plasma treatment, the PP film surface was activated, having free radicals and functional groups such as COOH and OH. Finally, the samples were taken out of the reactor and put into the acrylic acid solution to induce the graft polymerization.

The graft polymerization reactor was a flask with three openings, one of which is connected to a circumfluence condensation tube. The graft polymerization was carried out at selected temperatures and times with argon protection. After the graft polymerization, sticky polyacrylic acid (PAA) polymer was removed from the PP film first. Then

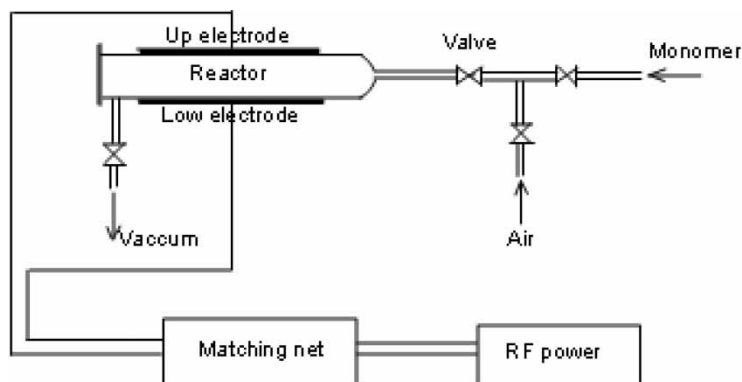

**Figure 1.** Scheme of the instrument for plasma graft polymerization.

the PP film was immersed in water for 24 h and treated with ultrasonics at 40°C to thoroughly remove the homopolymer PAA adhering to the film surface. In this way, it is assured that the remaining PAA polymer was chemically bonded to the PP film surface.

#### ***Determination of Grafting Ratio***

The amount of PAA grafted to the PP films was determined by the colorimetric method with Toluidine Blue O staining, as reported in the literature (7). The grafted film was placed in a  $5 \times 10^{-4}$  mol/L dye solution at pH 10 for 6 h at 30°C. The film was then taken out and thoroughly washed with a  $1 \times 10^{-4}$  mol/L NaOH solution to remove any inactive dye adhering to the surface. The dye was desorbed from the film in a 50% acetic acid solution, and the final dye content was obtained by the measurement of the optical density of the solution at 633 nm with an ultraviolet-visible spectrophotometer. The PAA content (grafting ratio) was obtained from a calibration plot of the optical density vs. dye concentration with a 1:1 ratio assumed between the dye and the carboxylic acid groups.

#### ***FTIR Measurement***

The PP films treated by plasma only, and both with and without plasma treatment and then grafted with AA under the same polymerization conditions, were measured with a Nicolet-20sx-B FTIR.

#### ***The Immobilization of CNTF on the Modified PP Films***

The immobilization process was as follows: PP films treated by plasma and grafted with AA were put into phosphate buffered saline (PBS) solution with Carbodiimide (EDC) for 30 min and were taken out for washing with a PBS solution. Then, the PP films were placed in a PBS solution with a certain amount of CNTF at 4°C for 24 h for the immobilization. After the immobilization reaction, the films were taken out for washing with PBS solution. The amount of CNTF immobilized on the surface of the modified PP films was measured by the ELISA method.

## Results and Discussion

### FTIR Spectrum

The infrared spectrum of the following PP film samples are compared in Figure 2. The sample treated by plasma only, and both with and without plasma treatment and then grafted with AA under the same polymerization condition. Although the infrared spectrum of PP film with plasma treatment only does not show obvious changes with that of original PP film, the spectrum of PP film treated by plasma and subsequently grafted with AA has a strong absorption peak at  $1700\text{ cm}^{-1}$ , which is the characteristic absorption peak of carbonyl functional groups. There is also a wide and middle-height absorption peak at  $3500\text{ cm}^{-1} \sim 3000\text{ cm}^{-1}$  belonging to hydroxyl groups. However, the spectrum of PP film grafted by AA but without plasma treatment does not show obvious peaks in these positions. So it is concluded that the plasma treatment and subsequent grafting with AA introduces functional groups such as COOH on the PP film surface. Thus, the plasma treatment is helpful for the grafting polymerization of AA on PP film surfaces.

### The Influence of Plasma Treatment Time on the Grafting Ratio

The influence of plasma treatment time of the PP film on the grafting ratio of AA is shown in Figure 3. For the same reacting conditions, the grafting ratio increases to a maximum value and then decreases with increasing the plasma treatment time of the PP film. This phenomenon can be explained by the process of plasma treatment and grafting

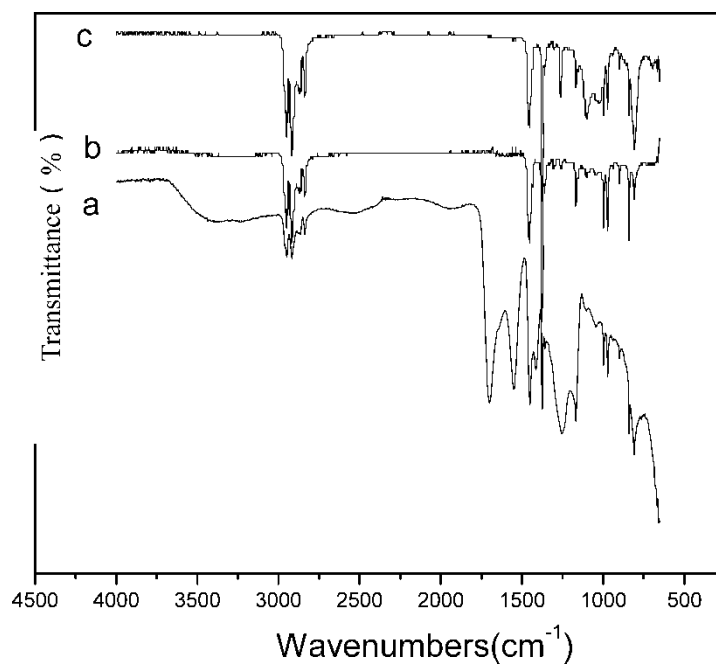

**Figure 2.** The FTIR spectrum of PP film. (a) Plasma-treated and grafted with acrylic acid; (b) Plasma-treated; (c) Treated with acrylic acid but without plasma.

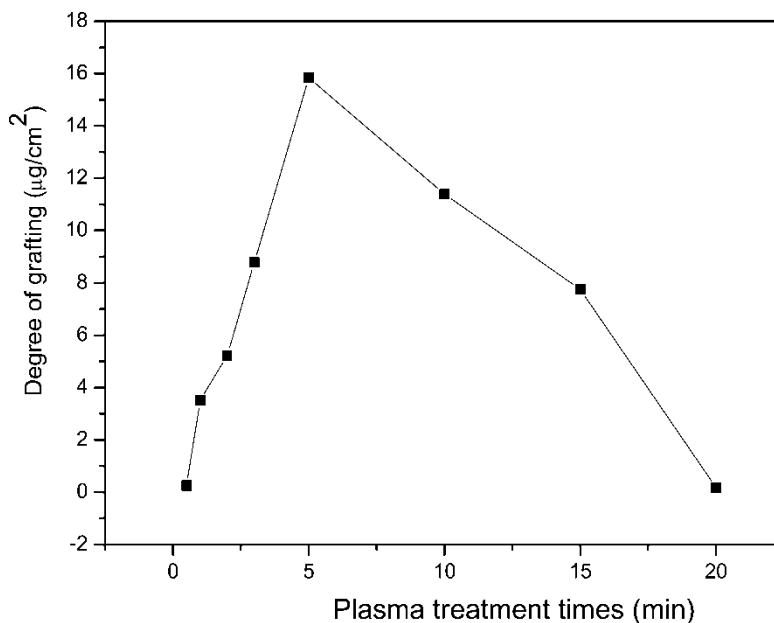

**Figure 3.** Variation of grafting ratio with plasma treatment time. Plasma treatment conditions: power = 40 W. Grafting conditions: reaction temperature = 50°C, radical density = 1.500 cm<sup>2</sup>/mL.

polymerization. In plasma treatment, there exist two opposite processes. One is the creating of active species such as free radicals or peroxide groups on the surface of PP film that can initiate the subsequent grafting reaction. The other is the etching of the surface of PP film. This leads to the dissociation and decreasing of the active species already formed on the surface. As the plasma treatment proceeds, the two processes reach a balance at a certain time. The amount of the active species on the PP film also reaches a critical value at this time. Therefore, the grafting ratio also reaches a maximum value at this time point.

#### *The Influence of Plasma Treatment Power on the Grafting Ratio*

Influence of the plasma treatment power on the grafting ratio of AA on PP film surface is shown in Figure 4, which shows the similar trend with that in Figure 3. The grafting ratio increases to a maximum value at the power of 40 W and then decreases with increasing plasma treatment power. The reason is as follows. At low power, the amount of active species on the PP film increase with increasing treatment power. At high power, the active species on the PP film dissociate and decrease with the increasing of power. The active species on the PP film surface reach a maximum at a certain power, therefore, the grafting ratio of AA on PP film surface also reaches a maximum at this power. These results are similar to some previous researchers (8).

#### *The Influence of Active Species Density on the Grafting Ratio*

We found that the grafting polymerization process is influenced by the number (total area) of the plasma-treated PP films put into the AA solution. The more the films, the faster the

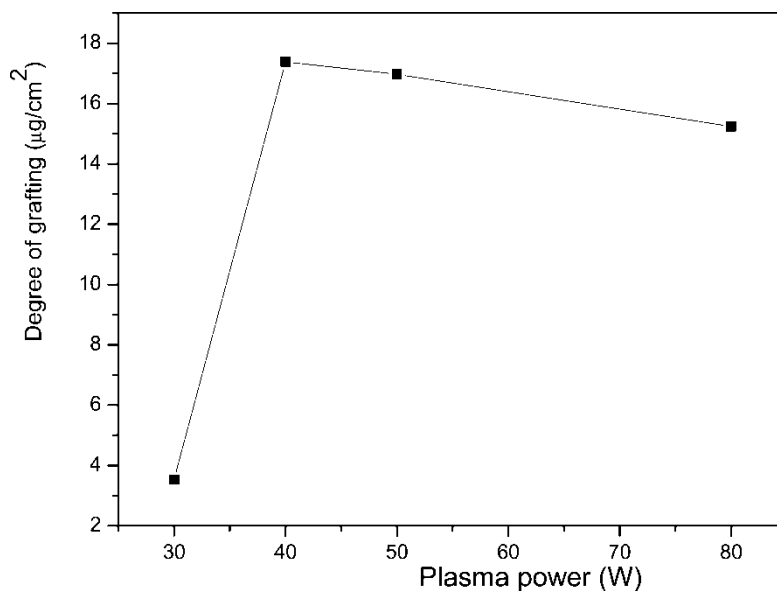

**Figure 4.** Variation of grafting ratio with plasma power. Plasma treatment conditions: time = 10 min. Grafting conditions: reaction temperature = 50°C, radical density = 1.500 cm<sup>2</sup>/mL.

graft polymerization reaction. This indicates that the plasma-treated PP films have some active species on the surface, acting as inducers or catalysts for the grafting polymerization. In order to express this effect quantitatively, the active species density is defined as the ratio of total area of the plasma-treated PP films put into the reaction medium divided by the volume of the polymerization reaction medium, that is

$$\text{active species density} = \frac{\text{area of the PP film}}{\text{volume of the reaction medium}}$$

The changes of grafting ratio of AA on PP film with active species density are shown in curves B and D in Figure 5. The grafting ratio increases at first and then decreases subsequently with increasing the active species density. It is also shown that the grafting ratio was higher for the PP film treated for a short time and at low monomer concentration (curve D) than that treated for a long time and at high monomer concentration (curve B). Corresponding photos of dyed PP films by Toluidine Blue O in curve D in Figure 5 are shown in Figure 6. The color yield of the dyed PP films corresponds to the grafting ratio. Plasma treatment conditions: power = 40 W, time: B = 10 min, D = 5 time; Grafting conditions: reaction temperature = 50°C, monomer concentration: B = 25%, D = 20%.

The changing trend in Figure 5 is estimated to be controlled by the amount of the active species density and the viscosity of the polymerization solution. In low active species density, the viscosity of the solution is not very high. Most active species could react with AA monomer molecules and take part in the grafting polymerization. Thus the grafting ratio increases with active species density. For a high active species density, the viscosity of the polymerization solution changes to a high value in a very short time. This prevents the active species from reacting with AA molecules, which therefore reduces the grafting ratio.

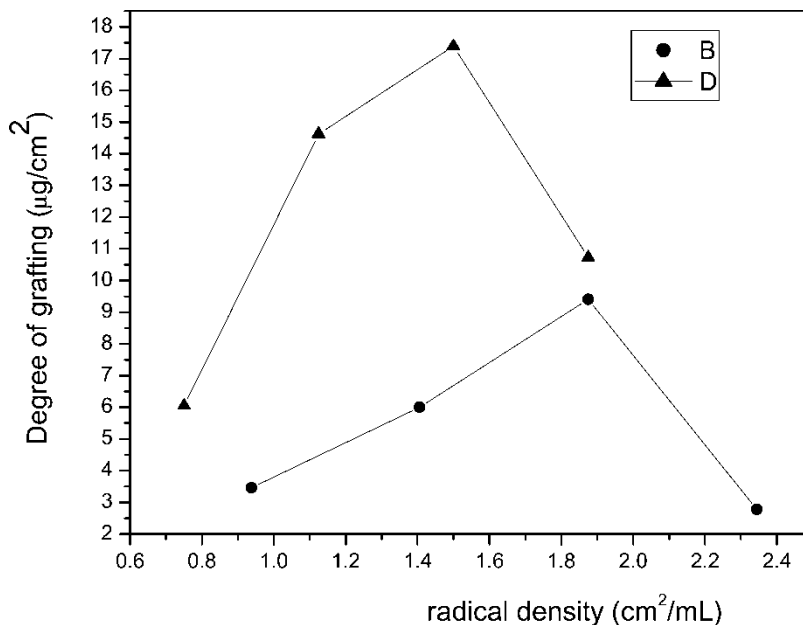

Figure 5. Variation of the degree of grafting with active species density.

#### *The Influence of Monomer Concentration on the Grafting Ratio*

The influence of the monomer concentration on the grafting ratio is shown in Figure 7. At first, the grafting ratio increases with increasing monomer concentration and reaches a maximum at concentration of 50%. After that, the grafting ratio decreases with increasing the monomer concentration. This result is affected by several factors, namely, the availability of monomer at the grafting sites, the extent of homopolymerization, the viscosity of the reaction system and the amount and availability of active species. In low monomer concentration, the viscosity of the reaction medium is low, and the active species can easily access the monomer molecules, resulting in chain initiation and propagation steps. On the other hand, once the homopolymerization starts, the viscosity of the reaction medium begins to increase. In high monomer concentration, the degree of homopolymerization is great and the Trommsdorf effect sets in, increasing the viscosity of the medium and decreasing the mobility of the chains and AA molecules greatly. This makes

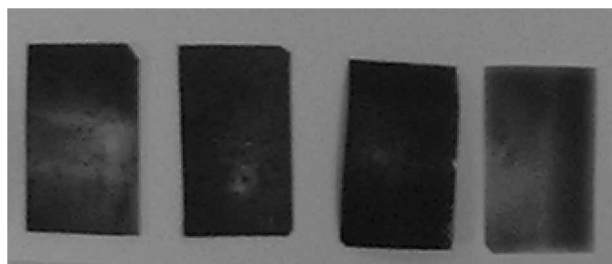
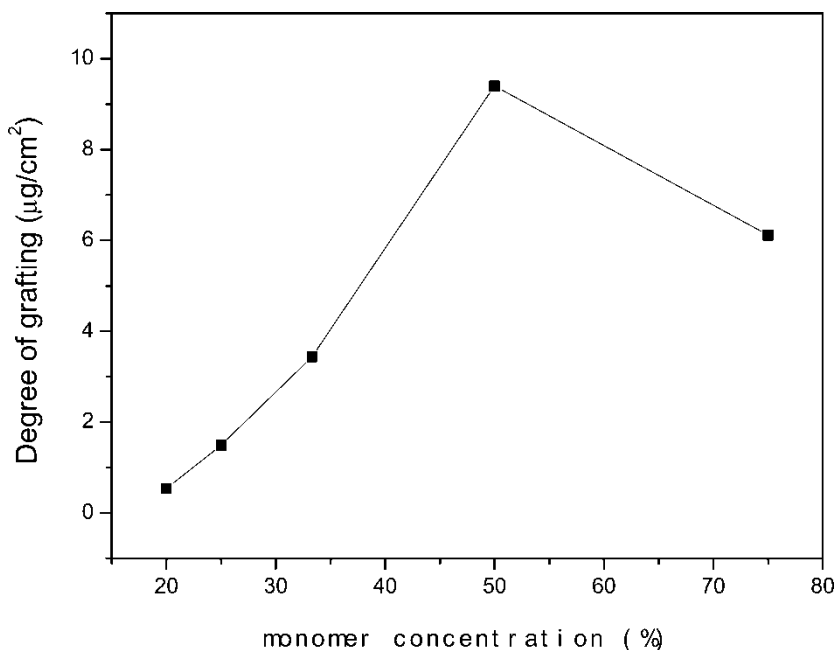

Figure 6. Photograph of dyed PP film. Plasma treatment and grafting conditions is according to curve D in Figure 5.





**Figure 7.** Variation of the grafting ratio with monomer concentration. Plasma treatment conditions: power = 40 W, time = 10 min. Grafting conditions: reaction temperature = 50°C, active species density = 1.875 cm<sup>2</sup>/mL.

chain transfer difficult and causes the termination of the chain propagation and the decreasing of grafting ratio. In this system, the grafting ratio shows a decreasing trend when the monomer concentration is beyond 50%.

#### ***The Influence of Reaction Temperature on the Grafting Ratio***

Variation of the grafting ratio at different temperatures is shown in Figure 8. Curves B and D in Figure 8 show that the grafting increases with increasing of the reaction temperature at first, and subsequently decreases. For the same temperature, the grafting ratio for short reaction time and low monomer concentration is higher than that for long reaction time and high monomer concentration.

At low reaction temperature, the initial rate of grafting polymerization increases with temperature for the same monomer concentration and resulting viscosities of the reaction medium. The faster the chain initiation and the propagating, the greater the monomer activity. This is of benefit to the grafting polymerization. As a result, the grafting ratio increases gradually with temperature. When the reaction temperature was above 50°C, the speed of chain propagation increases with temperature, which causes the long chains to react with each other to form large molecules. The viscosity of the reaction medium is high and hinders the accessibility of the monomers to the grafting sites. As a result, chain transfer takes place, which causes gel formation and decreases the grafting ratio. Moreover, high reaction temperature may cause the homopolymerization of AA molecules, which is harmful to the grafting reaction on PP films and decreases the grafting ratio.

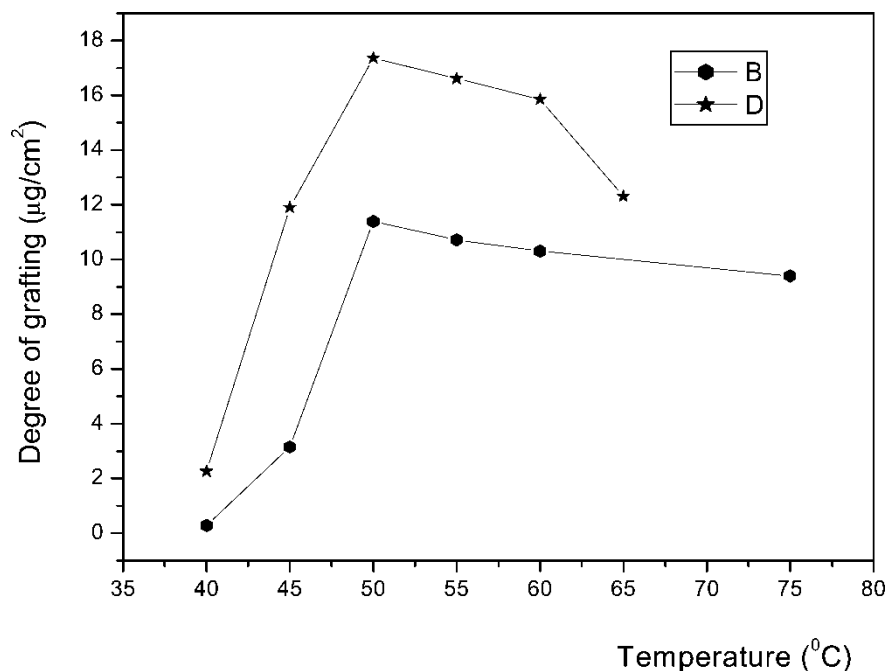

**Figure 8.** Variation of the grafting ratio with reaction temperature. Plasma treatment conditions: power: 40 W; time: B = 10 min, D = 5 min. Grafting conditions: active species density: B = 1.500 cm<sup>2</sup>/mL, D = 1.875 cm<sup>2</sup>/mL, Monomer concentration: B = 25%, D = 20%.

### *The Influence of Grafting Ratio of AA on the Immobilization of CNTF on PP Film Surface*

The PP film was modified according to the conditions of curve D in Figure 5. The influence of grafting ratio of AA on the immobilization of CNTF on the PP film surface is shown in Figure 9. The amount of CNTF immobilized on the plasma-treated PP films increased greatly, compared with that of untreated ones. The greater the grafting ratio, the greater the amount of immobilized CNTF. This shows that carboxylic acid graft chains have been successfully bonded on the plasma-treated PP films. The carboxylic acid grafted on the film surface is helpful to the immobilization the CNTF on the PP film surface. The reason is that the immobilization of the CNTF on the plasma-treated PP film is carried out through chemical bonds, which causes the CNTF to be immobilized on the PP film and not easy to remove by the washing process. But the immobilization of the CNTF on the untreated PP film is carried out through physical absorption and is easy to lose during washing.

### **Conclusions**

CNTF has been successfully immobilized on the plasma-treated and subsequently, AA-grafted PP films. This supplies a useful method to introduce bio-macromolecules on bio-materials.

Through choosing PP film as a model biomaterial, the CNTF immobilized on the PP film surface has been measured quantitatively and the mechanism of immobilization has

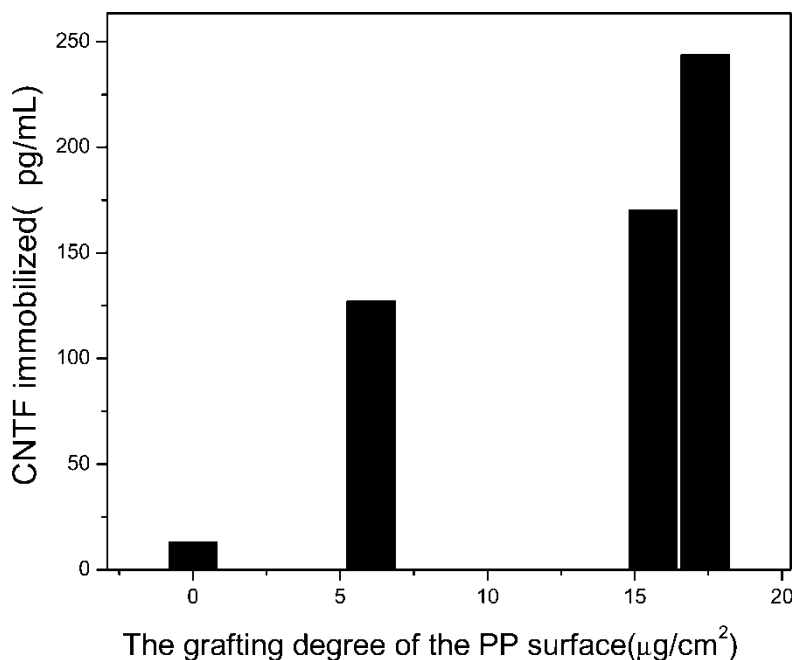

**Figure 9.** Immobilized CNTF vs. grafting ratio of AA on PP surface.

been investigated in detail. The amount of CNTF immobilized on the plasma-treated PP films increases with increasing grafting ratio of AA. The immobilization of CNTF proceeds through chemical bonding of carboxyl groups grafted on the modified PP film, whose existence has been proven by FT-IR and dye method.

The content of the grafted carboxyl (grafting ratio) could be controlled through controlling the parameters of plasma treatment and graft polymerization. The main factors are the power and time of plasma treatment, and the active species density, the monomer content and the polymerization temperature. Moderate conditions are of benefit to the grafting process.

### Acknowledgements

The authors would like to acknowledge support from the Scientific Research Foundation from the State Education Ministry (SRF for ROCS, SEM), and the Natural Science Foundation of Shanghai (00ZE14005, 027252045).

### References

1. Young, J.K., Kang, I.K., Huh, M-W., and Yoon, S.-C. (2000) *Biomaterials*, 21: 121–130.
2. Bisson, I., Marek, K.S.R., Bisson, I., Kosinski, M., Ruault, S., Gupta, B., Hilborn, J., Wurm, F., and Frey, P. (2002) *Biomaterials*, 23: 3149–3158.
3. Gupta, B., Hiborn, J., Bisson, I., and Frey, P. (2001) *J. Appl. Polym. Sci.*, 81: 2993–3001.
4. Feng, X., Zhang, J., Xie, H., Huang, Q., and Liu, W. (2003) *Surf. and Coat. Tech.*, 171 (1–3): 96–100.
5. Wang, C.C. and Hsiue, G.H. (1993) *J. Appl. Polym. Sci.*, 50: 1141–1149.

6. Bae, J.S., Seo, E.J., and Kang, I.K. (1999) *Biomaterials*, 20: 529–537.
7. Gupta, B., Plummer, C., Bisson, I., Gupta, B., Plummer, C., Bisson, I., Frey, P., and Hilborn, J. (2002) *Biomaterials*, 23: 863–871.
8. Shu, S.S., Koichi, K., and Yoshito, I. (1993) *Biomaterials*, 14: 817–822.
9. Lee, S., Hsiue, G., Chang, P.C., and Kao, C. (1996) *Biomaterials*, 17: 1599–1608.
10. Kang, I.K., Kwon, B.K., Lee, J.H., and Lee, H.B. (1993) *Biomaterials*, 14: 787–792.
11. Kato, K. and Ikada, Y. (1995) *Biotech. Bioeng.*, 47: 557–566.
12. Kato, K., Kikumura, Y., Yamamoto, M., Tomita, N., Yamada, S., and Ikada, Y. (1999) *J. Adhesion Sci. Technol.*, 1: 1–16.
13. Zhao, H.Q. (1993) *Plasma Chemistry and Process*, 1st Ed., Chinese Science and Technology University Press: Hefei, China.